

Behälter

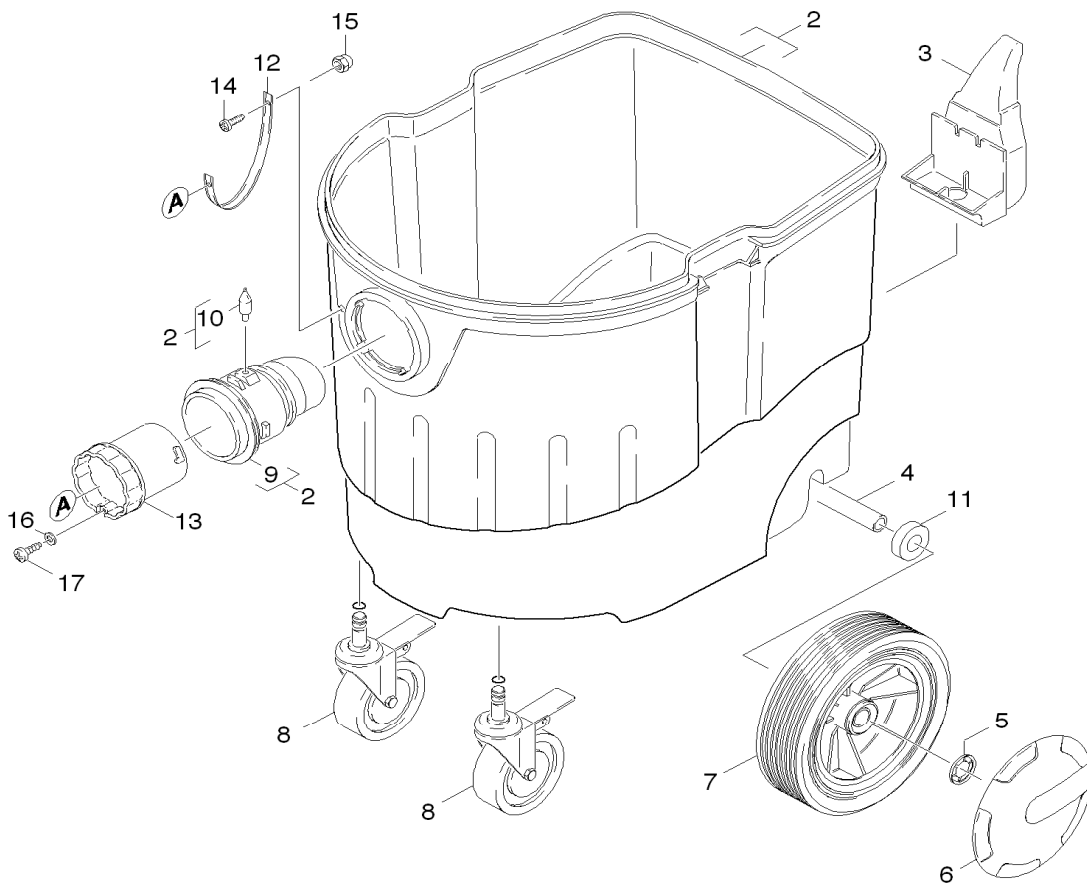

S 47 M

	Pos.	Teile-Nr.	Stückzahl
B	2	341.916	1
B	3	298.158	1
B	4	340.413	1
B	5	298.174	1
B	6	298.182	1
B	7	298.190	1
B	8	337.684	1
B	9	298.212	1
B	10	298.298	1
B	11	340.448	1
B	12	325.732	1
B	13	325.791	1
B	14	325.937	1
B	15	325.953	1
B	16	305.901	1
B	17	297.631	1

Filterrüttler

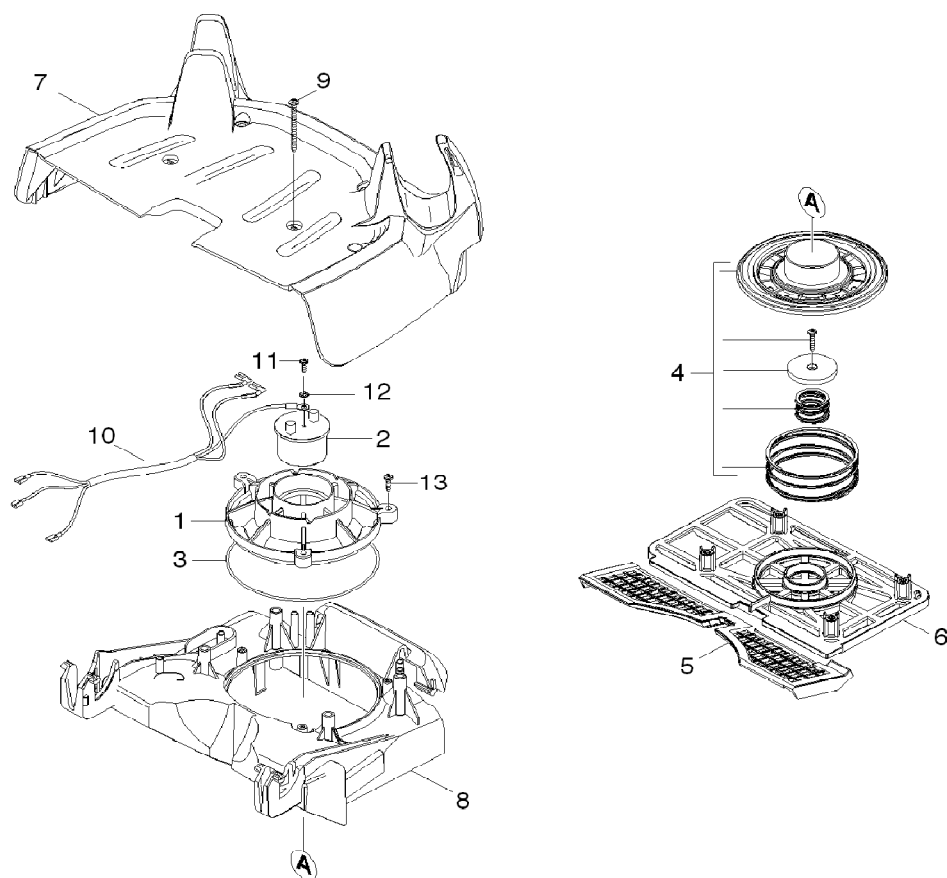

S 47 M

	Pos.	Teile-Nr.	Stückzahl
F	1	340.383	1
F	2	340.669	1
F	3	340.545	1
F	4	340.294	1
F	5	340.502	1
F	6	340.375	1
F	7	340.391	1
F	8	340.405	1
F	9	340.650	1
F	10	340.626	1
F	11	325.937	1
F	12	255.788	1
F	13	195.715	1

Haube

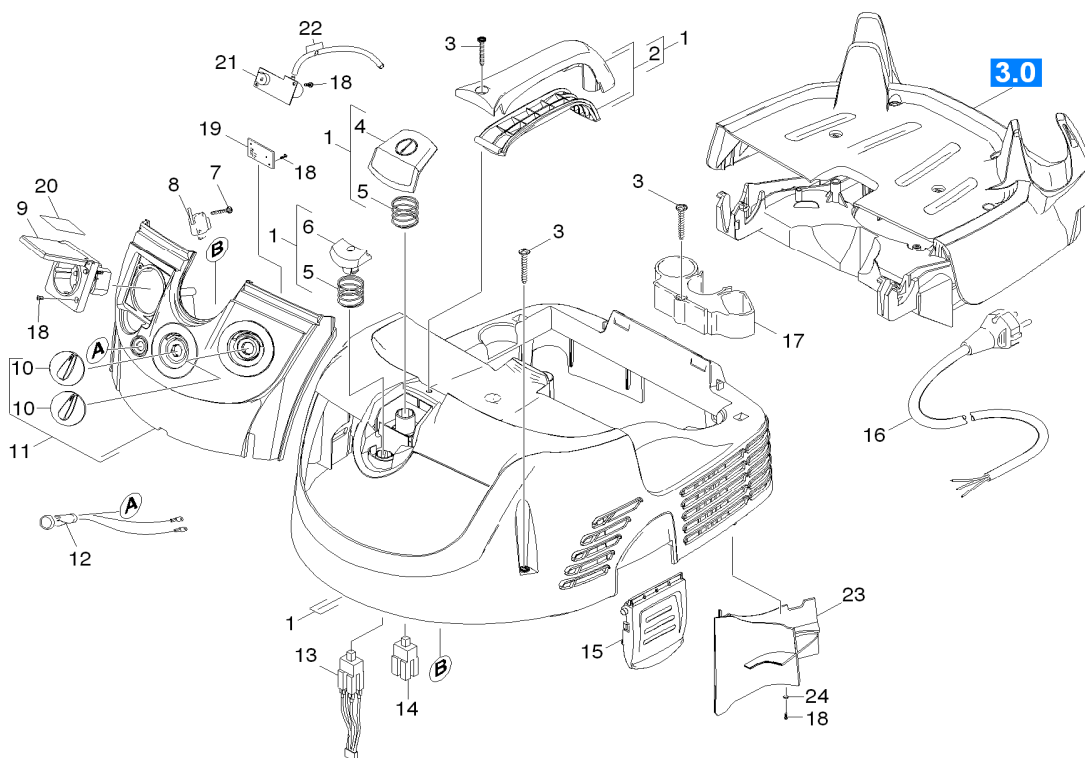

S 47 M			
	Pos.	Teile-Nr.	Stückzahl
H	1	341.789	1
H	2	337.641	1
H	3	337.706	1
H	4	341.797	1
H	5	340.499	1
H	6	341.800	1
H	7	329.797	1
H	8	297.615	1
H	9	297.607	1
H	10	341.819	1
H	11	341.827	1
H	12	297.593	1
H	13	340.596	1
H	14	340.618	1
H	15	337.668	1
H	16	297.534	1
H	17	297.542	1
H	18	325.910	1
H	19	340.359	1
H	20	297.623	1
H	21	341.835	1
H	22	341.843	1
H	23	341.851	1
H	24	341.878	1

Turbine

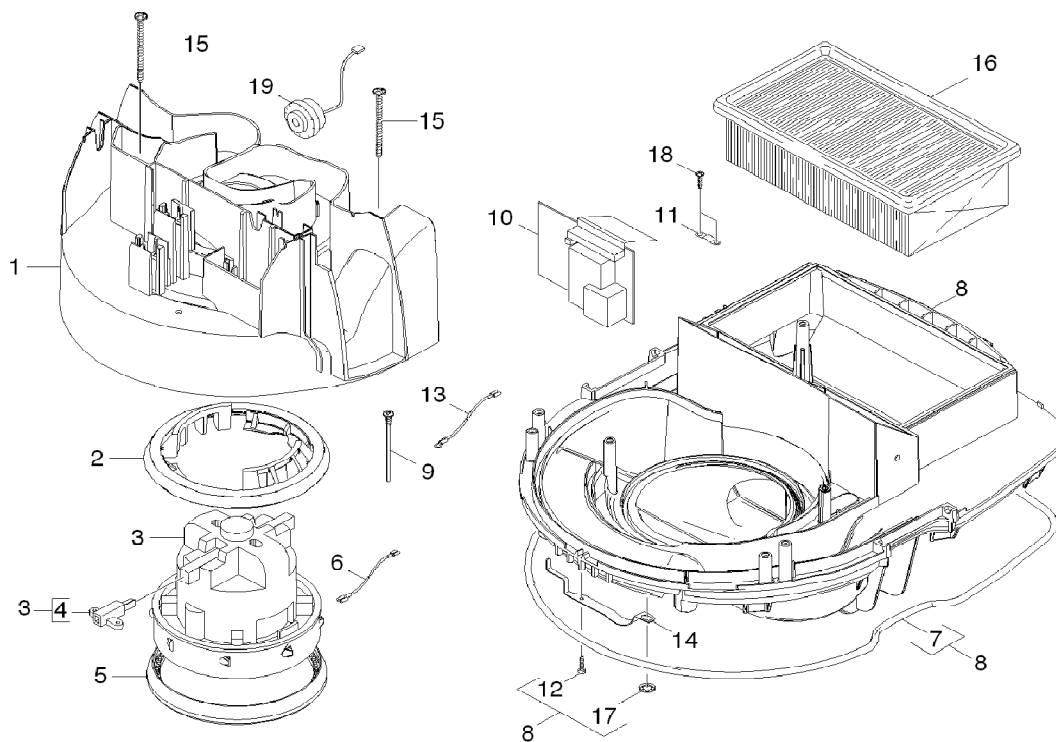

S 47 M

	Pos.	Teile-Nr.	Stückzahl
T	1	341.886	1
T	2	340.510	1
T	3	340.561	1
T	4	340.588	1
T	5	340.553	1
T	6	340.634	1
T	7	297.860	1
T	8	341.894	1
T	9	340.421	1
T	10	340.340	1
T	11	340.677	1
T	12	297.550	1
T	13	340.642	1
T	14	340.480	1
T	15	337.706	1
T	16	337.692	1
T	17	340.537	1
T	18	341.908	1
T	19	353.159	1

Zubehör

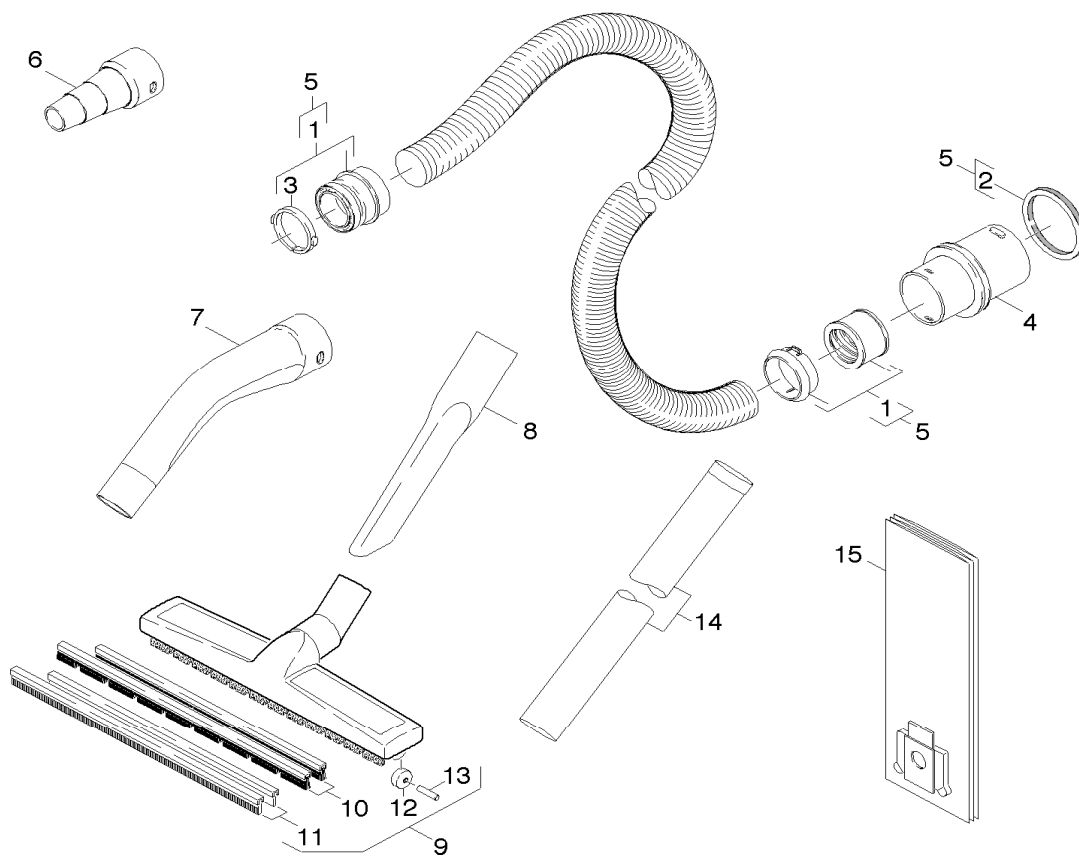

S 47 M

	Pos.	Teile-Nr.	Stückzahl
Z	1	296.988	1
Z	2	298.239	1
Z	3	379.654	1
Z	4	340.529	1
Z	5	341.770	1
Z	6	320.188	1
Z	7	342.548	1
Z	8	385.530	1
Z	9	300.659	1
Z	10	300.675	1
Z	11	300.683	1
Z	14	385.514	1