

FLEX

GRINDER/POLISHER

WARNING: Electrical repairs should only be attempted by trained repairmen. Contact the nearest Authorized Service Station.

L1503VR
120/USA

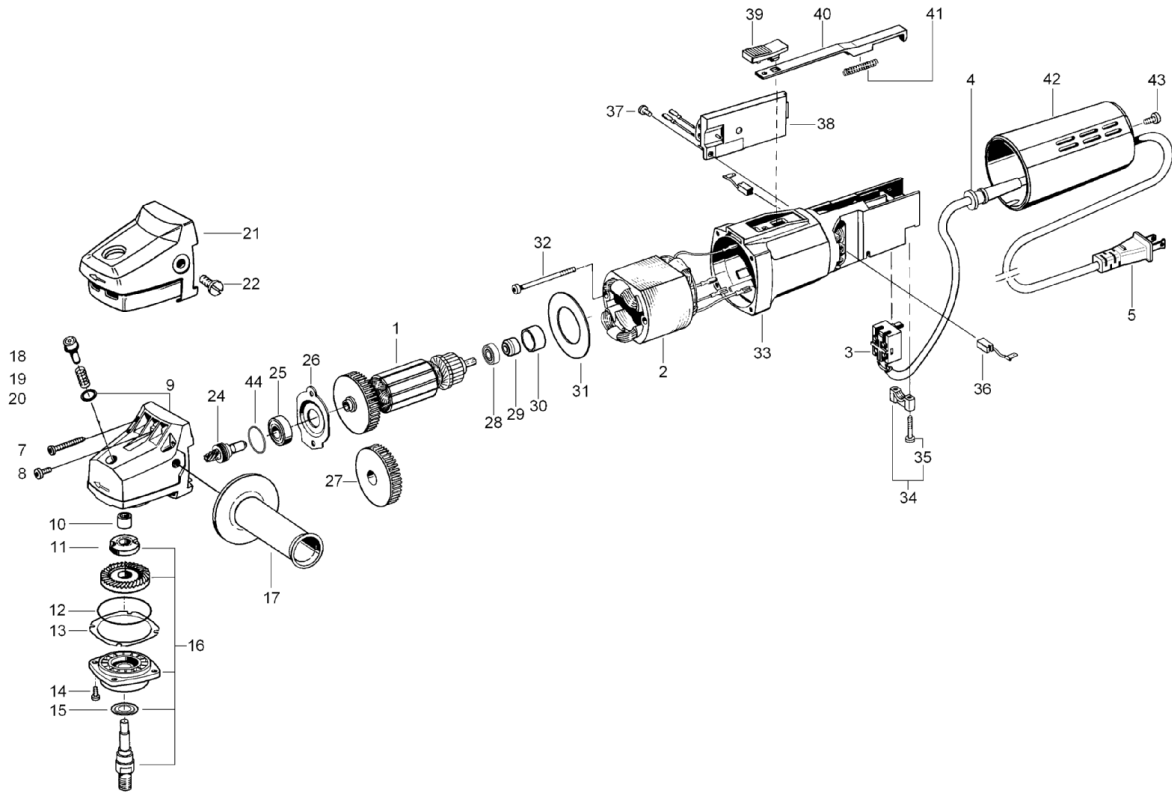

Ref. No.	Part No.	Description
1	241342	Armature
2	352128	Field
3	251331	Switch
4	197041	Cable Sleeve
5	218235	Cord cpl.
7	195693	Screw
8	258573	Screw
9	276642	Gear Housing
10	159271	Bearing
11	250597	Looking Disc
12	159204	O-Ring
13	257571	Washer
14	257782	Screw
15	268011	Sealing Ring
16	252294	Gear shaft Assembl.
17	198633	Side Handle
18	250265	Lock Button
19	250589	Spring
20	250266	O-Ring
21	259709	Crip Cap
22	211796	Screw
24	395560	Pinion
25	254442	Bearing

Ref. No.	Part No.	Description
26	257750	Bearing Cover
27	177644	Fan
28	254443	Bushing
29	219983	Magnetic Ring
30	209139	Bearing Ring
31	159247	Air Guide
32	225347	Screw
33	377988	Motor Housing
34	215074	Cable Clamp
35	213373	Screw
36	250816	Brush
37	195715	Screw
38	250918	Electronic
39	200506	Control Lever
40	225304	Control Rods
41	195820	Spring
42	336963	Cover
43	195715	Screw
44	315028	O-Ring

** 255691 Grease
** NOT SHOWN